

FG Wilson P150-5

Open Genset

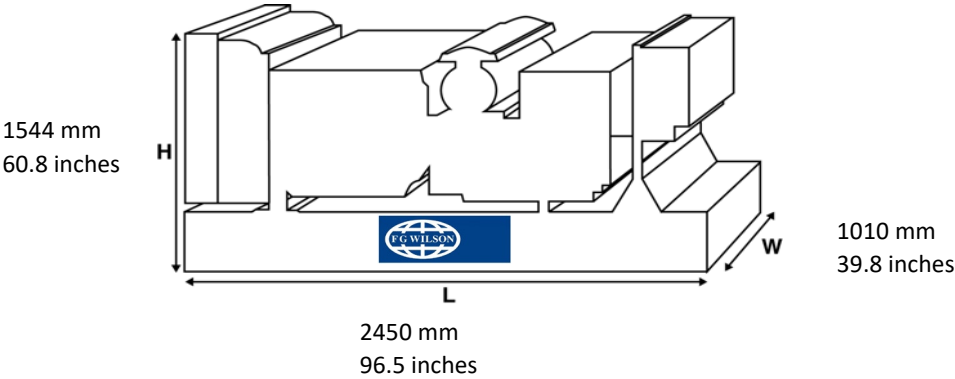

Weight with lube oil and coolant (no fuel) 1428 kg 3148 lb

Enclosed Genset with CALG canopy

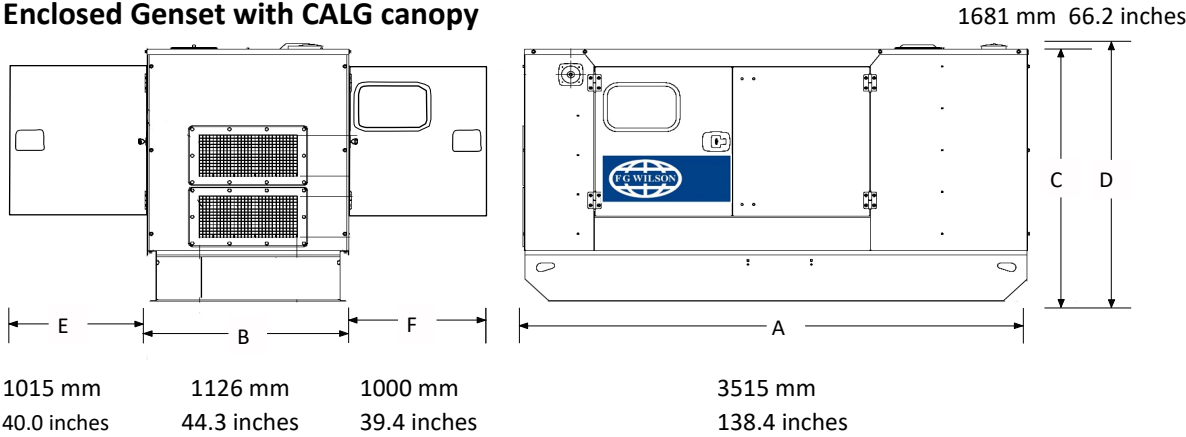

Weight with lube oil and coolant (no fuel) 1754 kg 3867 lb

Enclosed Genset with CAE canopy

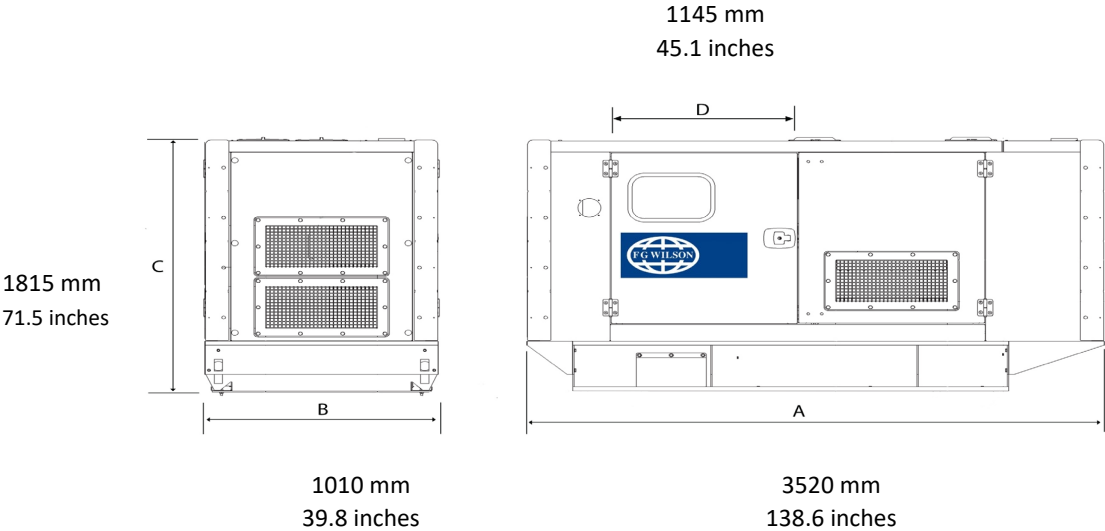

Weight with lube oil and coolant (no fuel) 1918 kg 4228 lb