

FG Wilson P200-3

Open Genset

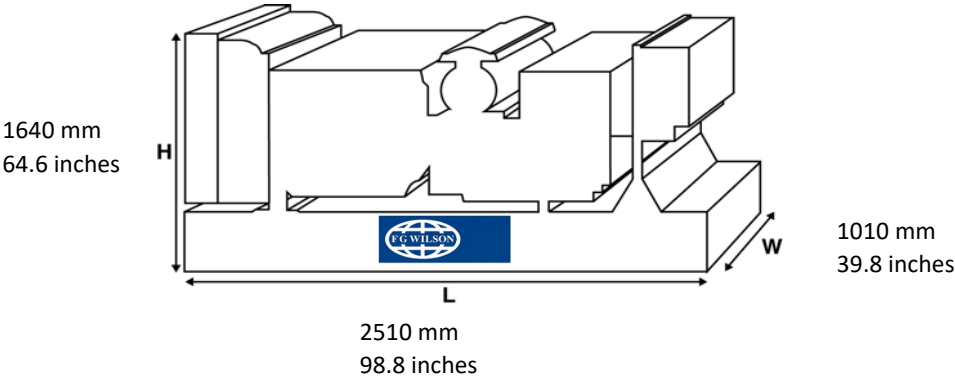

Weight with lube oil and coolant (no fuel) 1579 kg 3481 lb

Enclosed Genset with CALG canopy

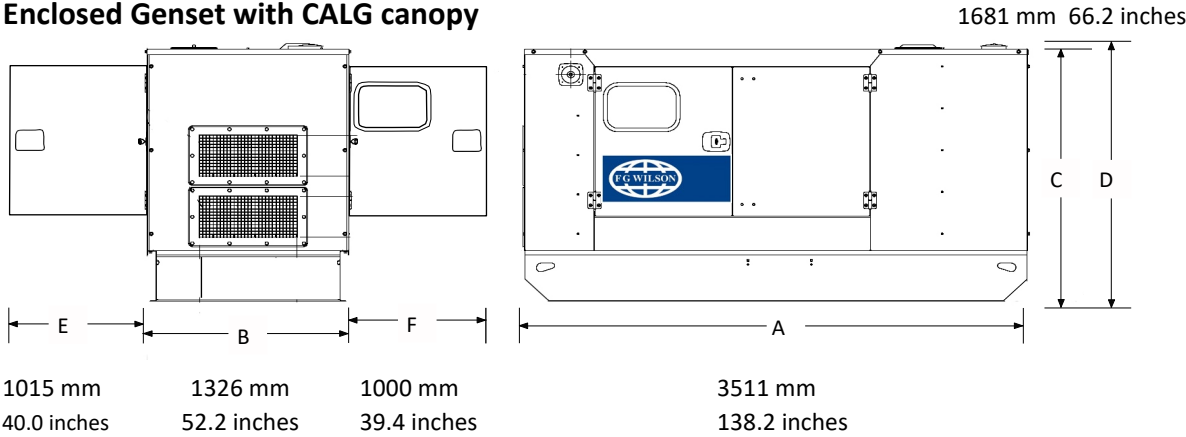

Weight with lube oil and coolant (no fuel) 2074 kg 4572 lb

Enclosed Genset with CAE canopy

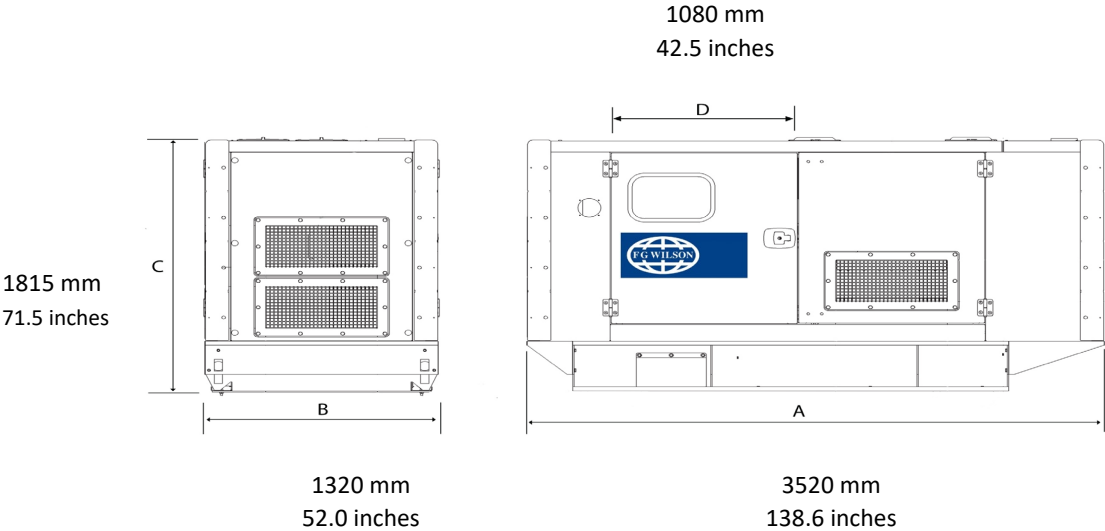

Weight with lube oil and coolant (no fuel) 2198 kg 4846 lb