

FG Wilson P26-3S

Open Genset

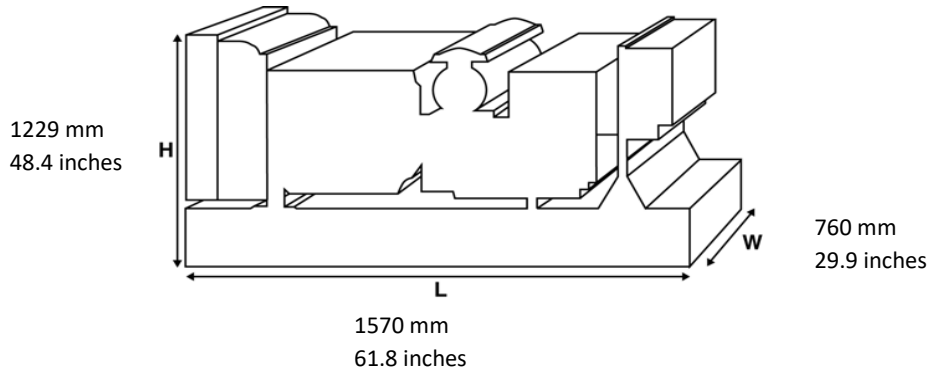

Weight with lube oil and coolant (no fuel) 699 kg 1541 lb

Enclosed Genset with CALG canopy

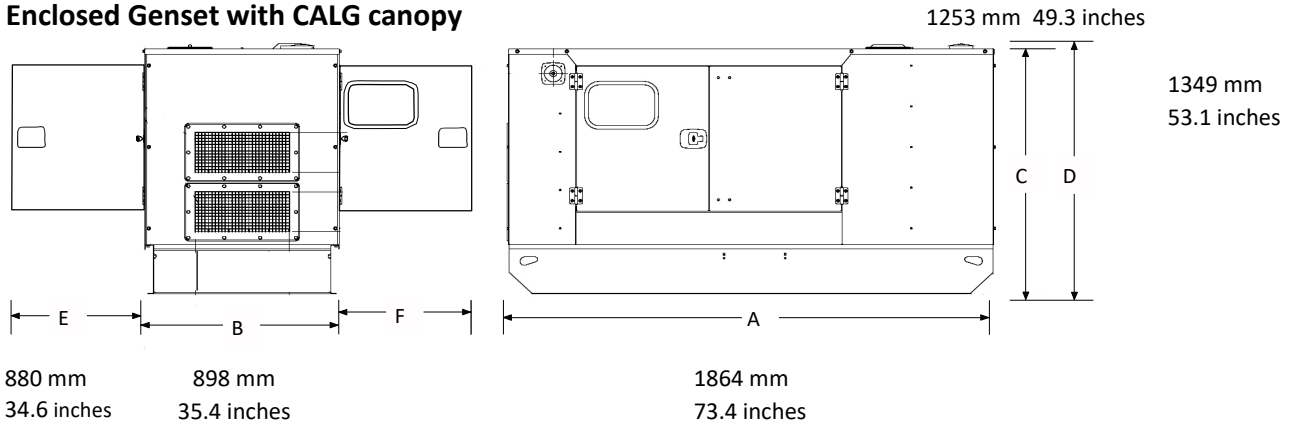

Weight with lube oil and coolant (no fuel) 859 kg 1894 lb

Enclosed Genset with CAE canopy

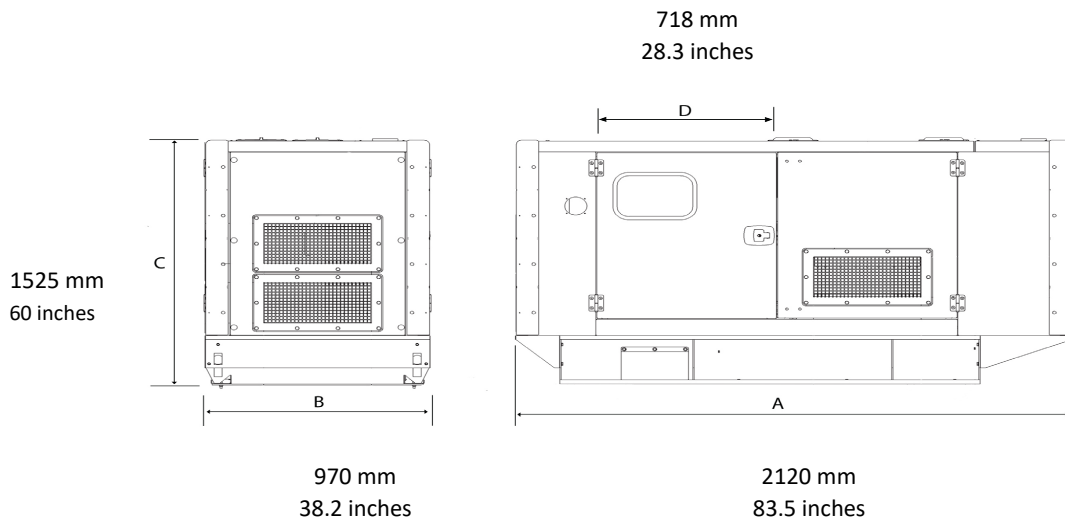

Weight with lube oil and coolant (no fuel) 991 kg 2185 lb