

FG Wilson P33-3

Open Genset

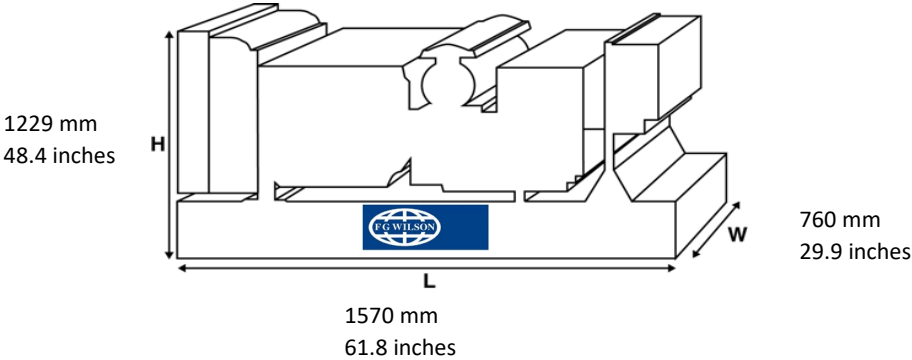

Weight with lube oil and coolant (no fuel) 712 kg 1570 lb

Enclosed Genset with CALG canopy

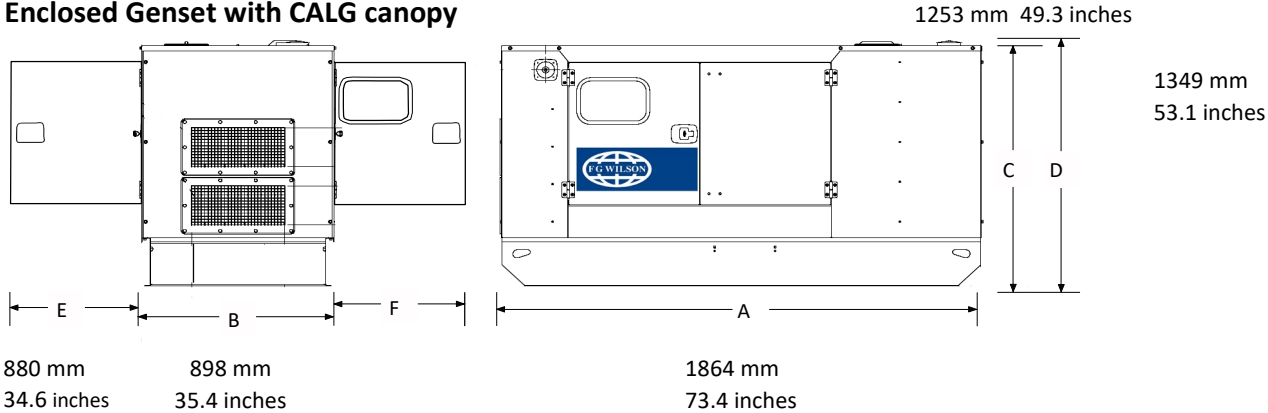

Weight with lube oil and coolant (no fuel) 846 kg 1865 lb

Enclosed Genset with CAE canopy

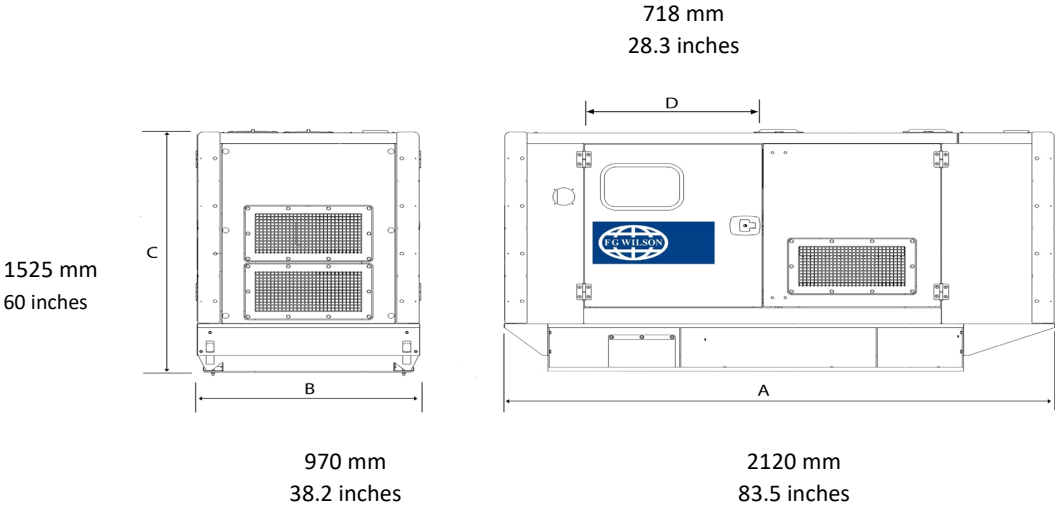

Weight with lube oil and coolant (no fuel) 991 kg 2185 lb