

FG Wilson P50-5S

Open Genset

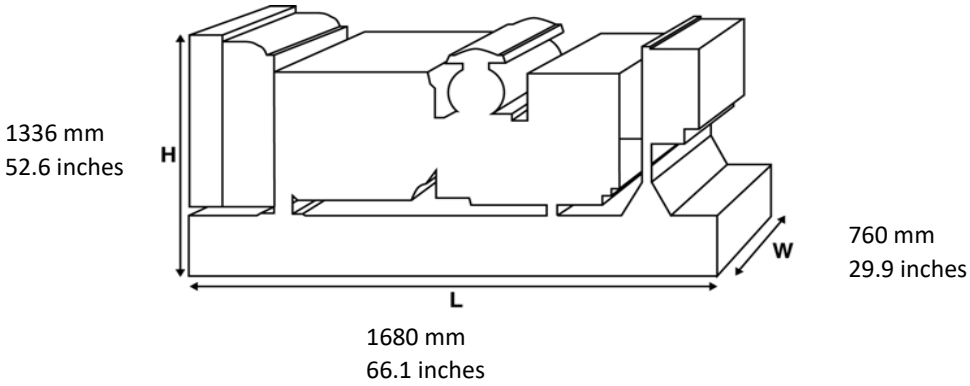

Weight with lube oil and coolant (no fuel) 912 kg 2011 lb

Enclosed Genset with CALG canopy

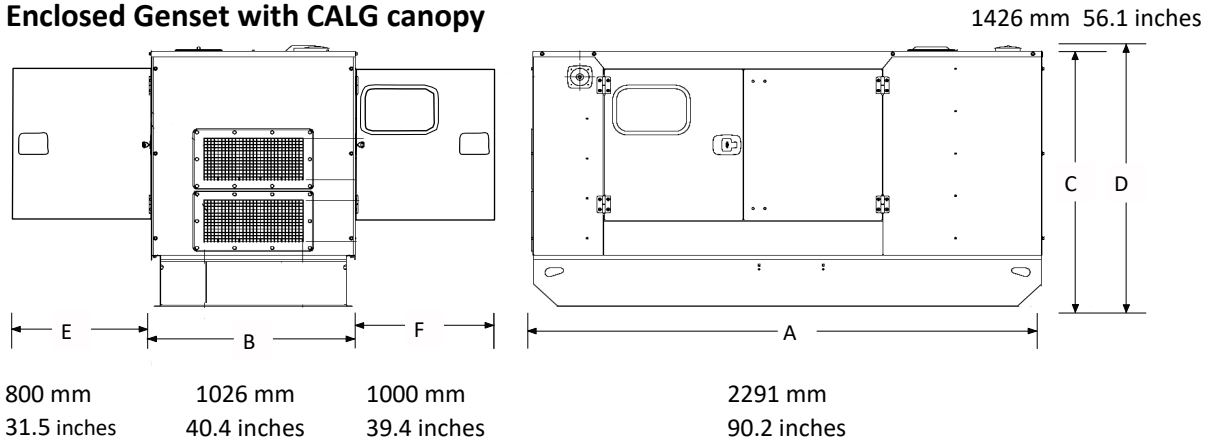

Weight with lube oil and coolant (no fuel) 1127 kg 2485 lb

Enclosed Genset with CAE canopy

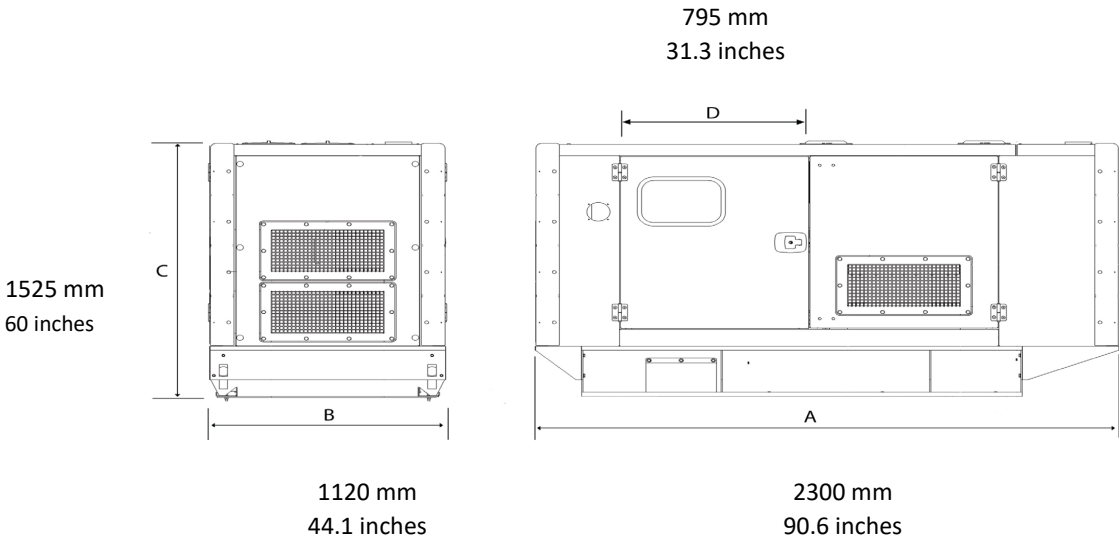

Weight with lube oil and coolant (no fuel) 1340 kg 2954 lb