

**FG Wilson P55-3**

**Open Genset**

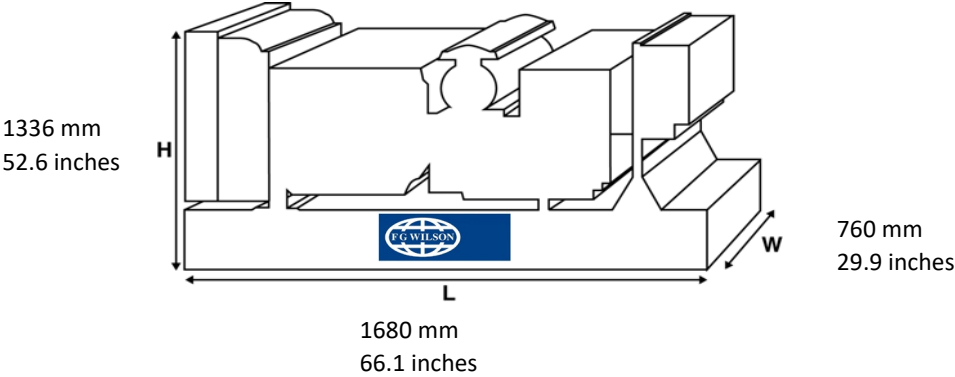

Weight with lube oil and coolant (no fuel) 810 kg 1786 lb

**Enclosed Genset with CALG canopy**

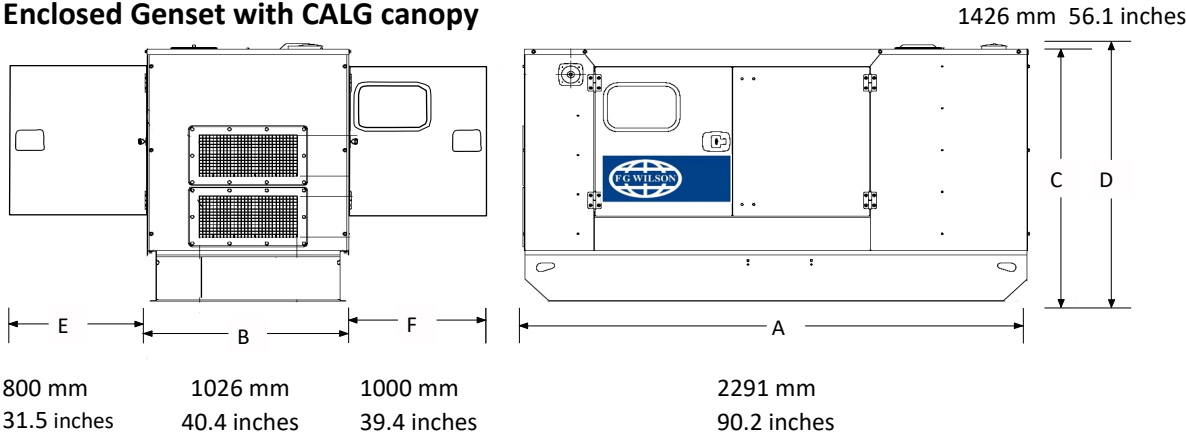

Weight with lube oil and coolant (no fuel) 1025 kg 2260 lb

**Enclosed Genset with CAE canopy**

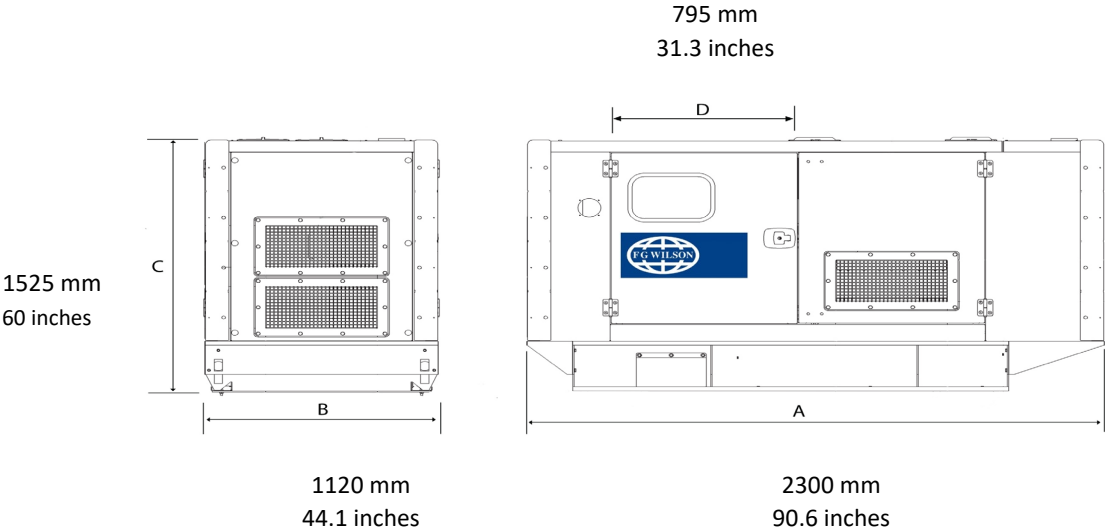

Weight with lube oil and coolant (no fuel) 1196 kg 2637 lb