

FG Wilson P65-5

Open Genset

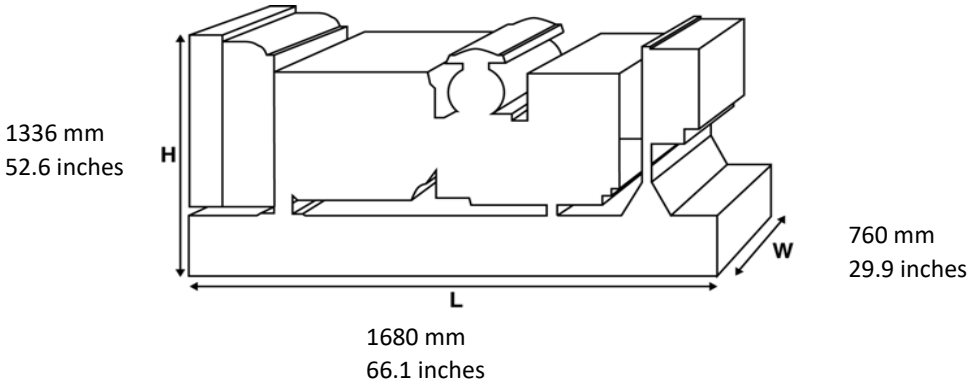

Weight with lube oil and coolant (no fuel) 852 kg 1878 lb

Enclosed Genset with CALG canopy

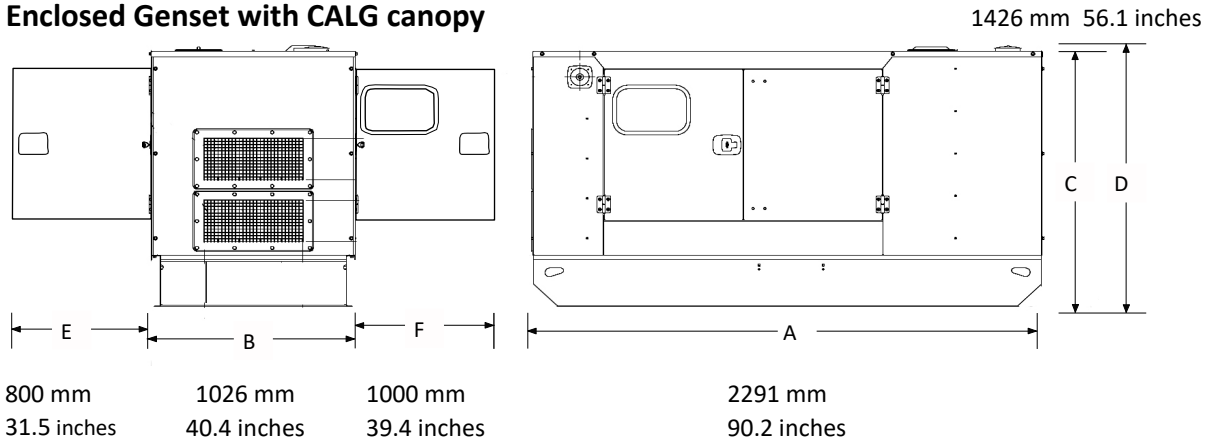

Weight with lube oil and coolant (no fuel) 1067 kg 2352 lb

Enclosed Genset with CAE canopy

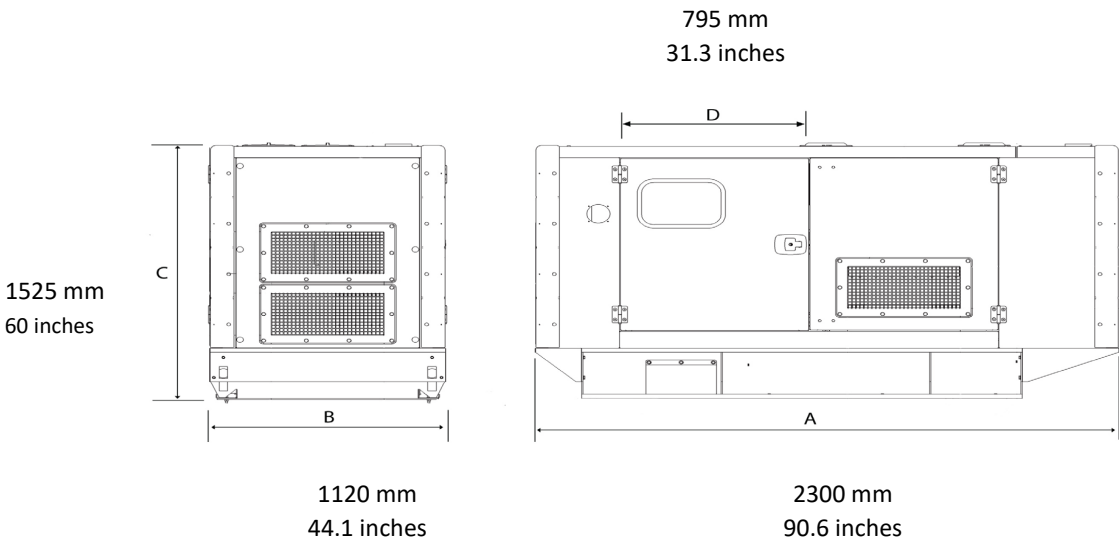

Weight with lube oil and coolant (no fuel) 1207 kg 2661 lb